

OSLO PENINSULA

Size 900x900x2000mm

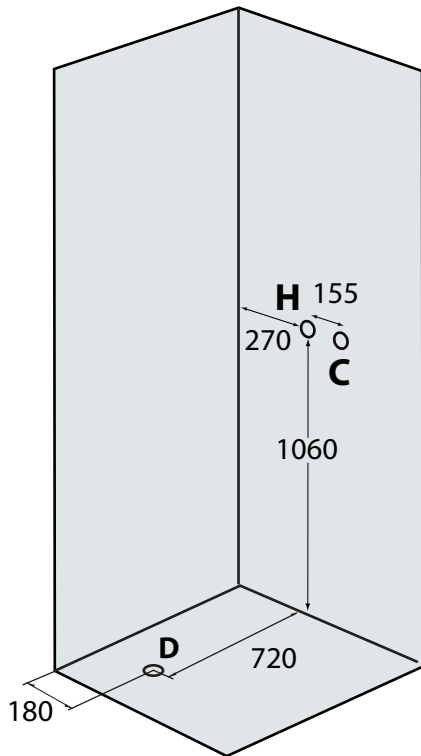

Key

H = Hot water feed

C = Cold water feed

D = Drainage

All measurements are in mm.

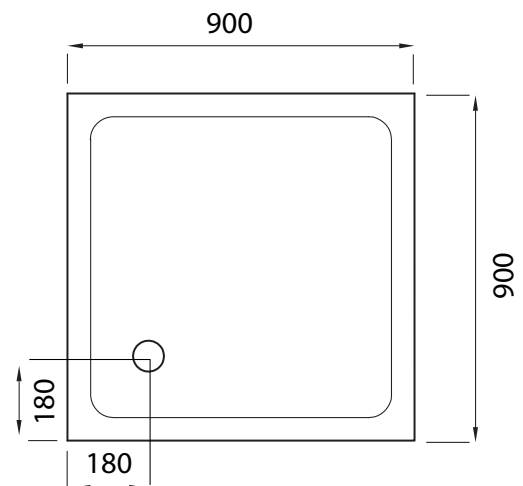
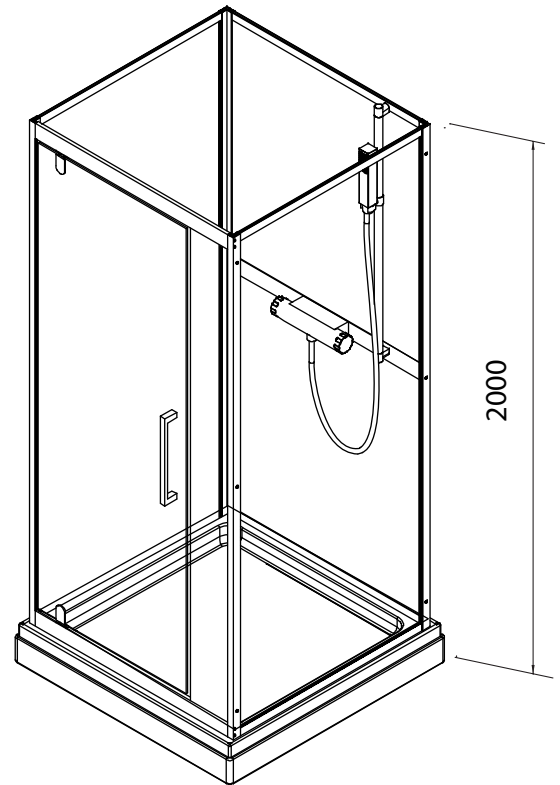

Delivery

These showers are sectional and will be delivered in three boxes for assembly on site. All the sectional pieces will fit through standard doorways and up stairways.

Basics

These showers are free standing and silicone free units that simply require assembly and connection to the following services;

Hot and cold water (Minimum of 0.5 bar).

Drainage.

Assembly

You will require access all around the unit in order to assemble it. Once assembled the unit can be simply connected via the flexible pipes provided and pushed back into position. The rear wall panel is completely obscured and it is not necessary to tile behind the shower although it should be sited on a firm level surface. N.B. It's also possible to order this model with either side wall panel obscured.

Connection / Water

Hot and cold water connection is via two 100cm metal braided flexible 15mm pipes with female connectors (supplied).

These pipes are connected to the standard size thermostatic bar mixer tap (supplied) behind the shower at the location shown on the diagram above. These showers will work with a combination boiler or any system that can provide adequate water pressure.

Connection / Waste

The shower has an easy plumb raised tray built over a stainless steel box frame with adjustable feet. The tray has a removable front skirt and is fitted with a 90mm fast flow shallow trap and comes complete with an extendable flexible waste pipe.